

MALFUNCTION ELIMINATES:

Vehicle couldn't move	1, Check whether the power switch is off.
	2, Check whether the forward/backward switch is in the neutral gear (in the middle)
	3, Check the fuse is damaged, if so, change it.
	4, Check whether the battery wires are connected well?
	5, Charger's dc in the charging socket will make it not work, if so, take it out.
	6, Check whether stepped on the pedal.
	7, Check whether anything trapped in the wheels.
Vehicle move slowly	1, Check whether the battery be fully charged.
	2, Check whether anything trapped in the wheels.
	3, Check whether the vehicle is over loaded.
Vehicle cannot be charged	1, Check whether the charger or battery is damaged.
	2, Check whether the charger and the battery is well connected.
	3, The charger or battery if there is a loose connection.

WARNING

- This note is to use illustrations to illustrate the operation of the product and product structure, there are a few differences, in kind prevail.
- In order to improve the quality of the products, under the condition of without telling, we may make changes to the product part of the structure with the appearance, please understanding

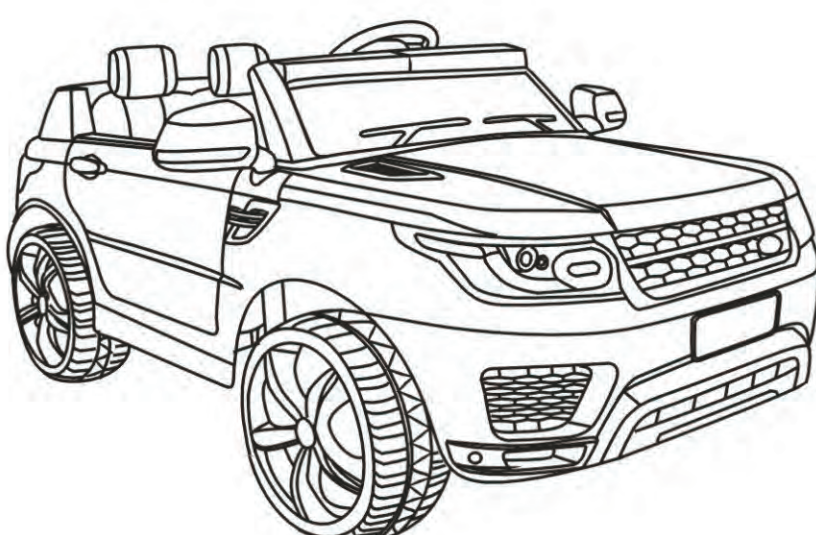

- Suitable age 37-95months.
- This product should be assembled by adult.
- This instruction contains important safety information content, please keep it as a reference.

About the products

Thank you for choosing our children electric car. We always keep pursuing being outstanding and designing comfortable and safe ride on car for children, and give your children a wonderful childhood.

Please read this instruction carefully before use, it will tell you the right way of assembling and operating. To avoid incorrect operations damaging the product or injuring your baby, please keep this instruction.

Specifications

Battery:	12V4.5Ah		
Main material:	PP		
Suitable age:	37-95months	Maximum weight:	30kg
G.W:	20kg	N.W:	16kg
Car Size:	110x68x52cm	Package Size:	110x58x37cm
Speed:	3-5km/h		
Operation time:	1-2hours after charging about 8-12hours		
Charge:	Input AC220V; Output DC12V500mA		
Fuse:	Resettable Fuse		

Part List

Part Number	Part Name	Picture	Q'ty (pcs)	Part Number	Part Name	Picture	Q'ty (pcs)
1	Main body		1	2	Seat		1
3	Wind shield		1	4	Steering wheel		1

-1-

-10-

To avoid the fuse trip cause cut the power, please note the things as follows:
The max loading is 30kgs, do not over the loading.
Do not drag everything.
Do not let the water or other liquid touched the circuit, battery and other parts.

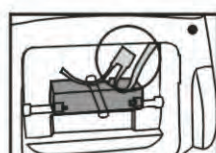

Never modify the structure and the electric circuit system.

CHARGE

- This product charge should by adult for safety.
- Before first use should open the seat, the line s connected (red to red, black to black) please charge at least 8-12 hours.
- The charging jack is on the fuel tank cap, the steps as follows:
- When drive slow, should charge 8-12hours in time, can't be over 20hours.

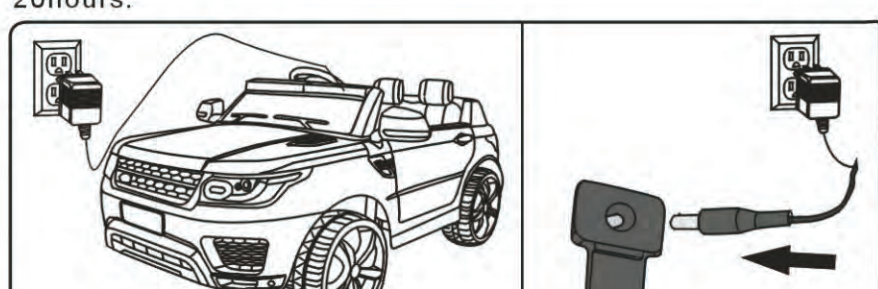

1. Insert the charger tap charging hole
2. Insert the charger to the power socket (The car won't start for charging status)

NOTE:

- Only Only can use the manufacturers specified battery and charger.
- The old and new batteries and different types of batteries cannot be mixed use.
- Do not open the battery and charger.
- Do not overturn the battery.
- Before charge, please confirm whether the charger battery and the jack are well, if damaged, stop use, until restored.
- When charging, the battery will be warm, it's regular or the battery maybe damaged.
- Must use the platen fasten the battery, the battery will hurt the children when the car overturn.
- The adult should bring out the battery, proper recycling.
- When the car will be not used for long time, ensure it be charged and charge once every 3 month to keep the battery life.
- The charger is not toy, keep it away from the children.

-9-

-2-

Part Number	Part Name	Picture	Q'ty (pcs)	Part Number	Part Name	Picture	Q'ty (pcs)
5	Rear-view mirror		1	6	Direction axis		1
7	Driving wheel		4	8	Wheel Cove		4
9	Rear wing		1	10	Remote Control		1
11	Charge		1	12	Tool bag		1
13	Gear box		2	14	Instruction		1
15				16			
17				18			

LEAN CARS

WWW.LEAN

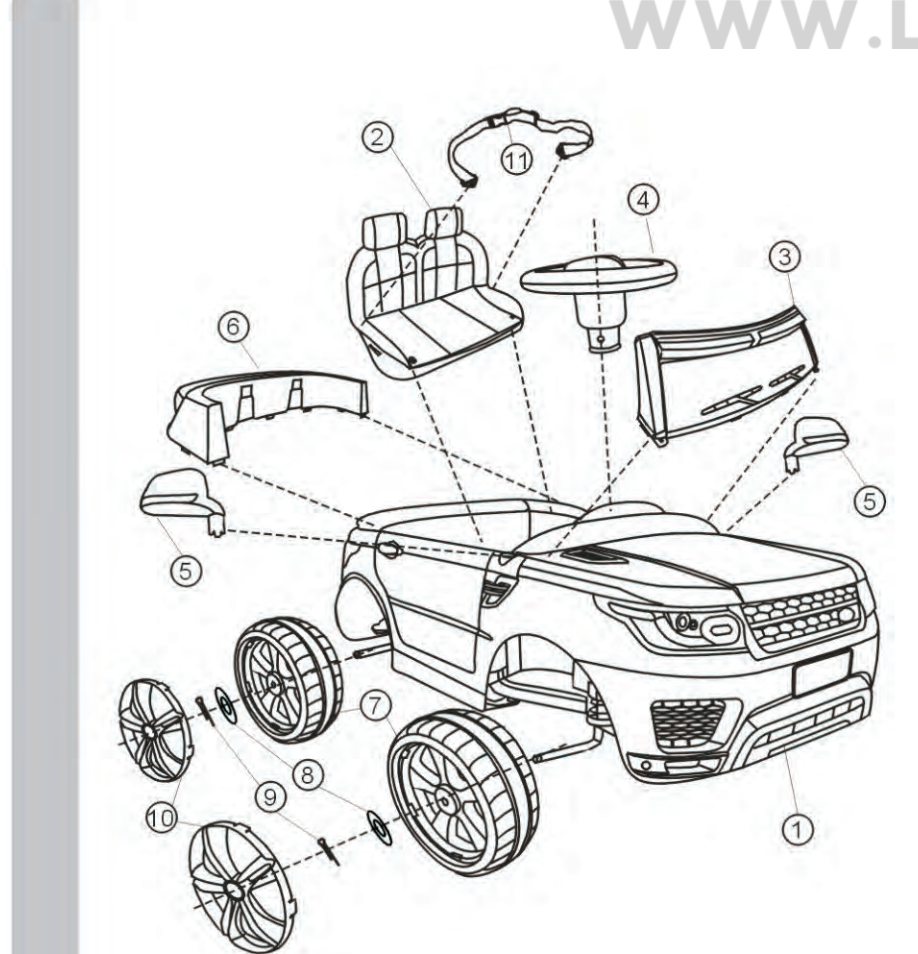

Part Number	Part Name	Part Number	Part Name
1	Main body x1	6	Gasket x6
2	Seat x1	9	Split Pin x4
3	Wind shield x1	10	Wheel Cove x4
4	Steering wheel x1	11	Safety belt x1
5	Rear-view mirror x1	12	
6	Rear wing x1		
7	Driving wheel x4		

-3-

-8-

HOW TO OPERATE YOUR VEHICLE

- Before use, must be confirm the product as follows:
 - According to the instruction assemble the car, connected well.
 - Make all the screws fastened tightly in the right place.
- Before driving, parents should tell your children safety rules and make them understood.
 - In order to reduce dangerous:
 - Please sit on the seat when driving.
 - Only one child drive every time.
 - Driving must be under the adult supervision.
 - Note the driving in safe place, keep driving on hard and flat ground.
 - DO NOT drive in dangerous places.
 - a. ditch pit, river side, slopes or other uneven ground.
 - b. Beside the road or other places for cars and people walking.
 - c. Barrier which might cause damage and injury.
 - d. Other dangerous places.
 - Do not drive in black, it may cause injury. Do drive in day time or bright places.

2. OPERATE AS FOLLOWS

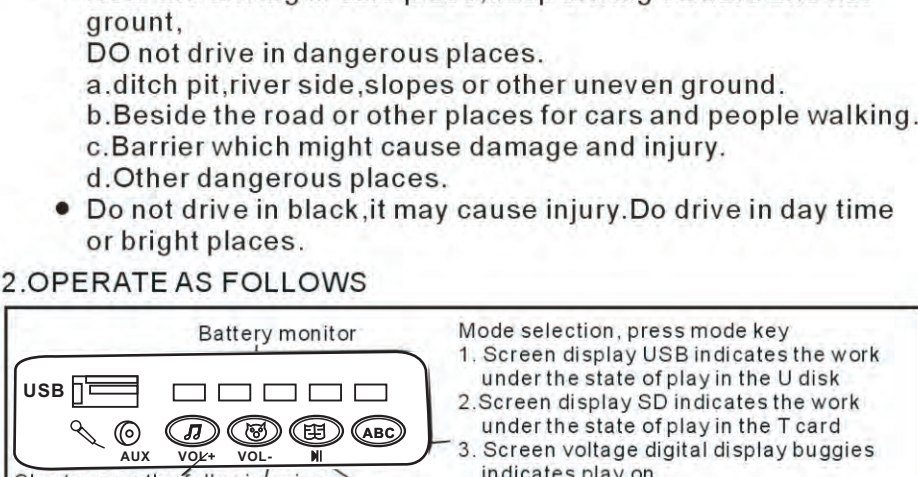

Note: Must tell your children, When change gears, release the foot switch, after the car stopped.
Do not change gears when the car is driving, or damage the line and other parts.

-7-

Assembling

- The vehicle should be assembled by adult before use.
- The small parts might cause choke, please keep away from the children. Children under 36 months can not use.
- Please check the number of the parts before assembling, and keep the packaging bags away from the children in case of choke.

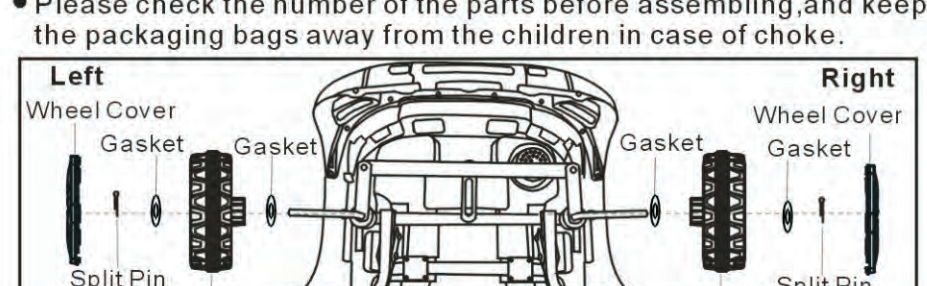

1. Assemble the front wheel
Turn over the car body. Fix the gasket, wheel, gasket onto the front axle from each side. Fasten tightly with the split pin, put on the wheel cover and cap.

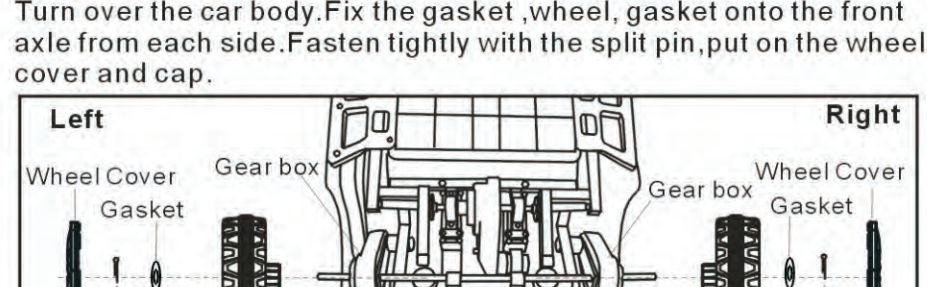

2. Assemble the back wheel
As showed in the picture, fix these parts onto the back axle. Fasten tightly with the split pin, put on the wheel cover and cap.

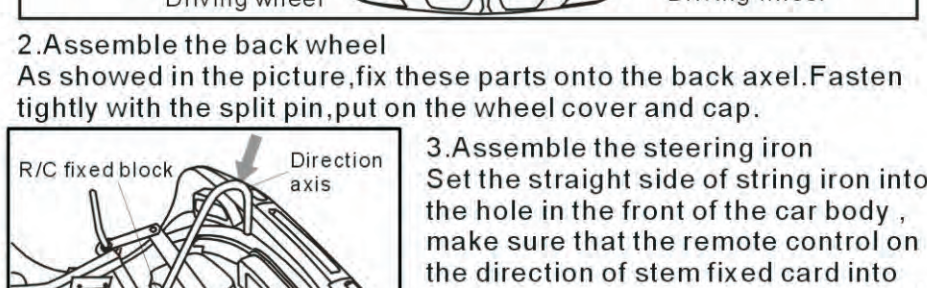

3. Assemble the steering iron
Set the straight side of string iron into the hole in the front of the car body, make sure that the remote control on the direction of stem fixed card into the steering gear box groove, through the hole of the hole front axle by bend at one of the iron.

-4-

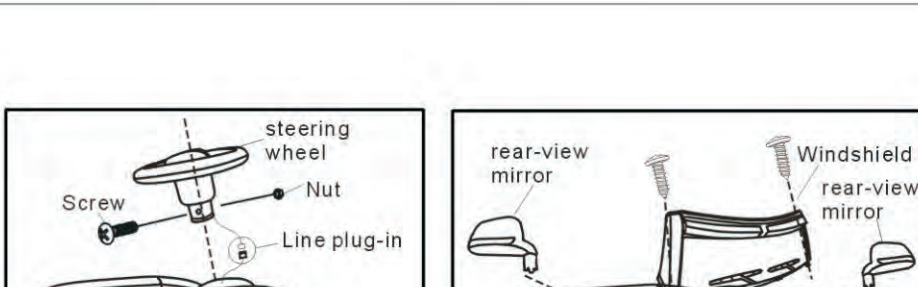

4. Assemble the steering wheel
Insert cable plug-in well first, then hold the steering wheel in the steering rod, fixed it by screws and nuts.
5. Assemble the mirror
Insert the mirrors into the hole on the car body tightly.
6. Assemble the wind shielder
Aim the wind deflector neck car body down on inserts, fix with two self-tapping screws on both sides

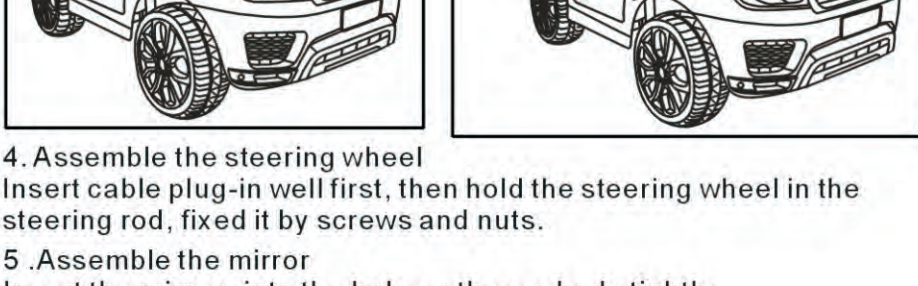

7. Connect the power
As showed in the picture, connect the motor plug-in with the car, then connect the power plug-in with the right direction.
8. Assemble the empennage and seat cushion
buckle into the body corresponding to the position, fix the snap with the neck on the car body, then fasten by reocuppy two self-tapping screws

-5-

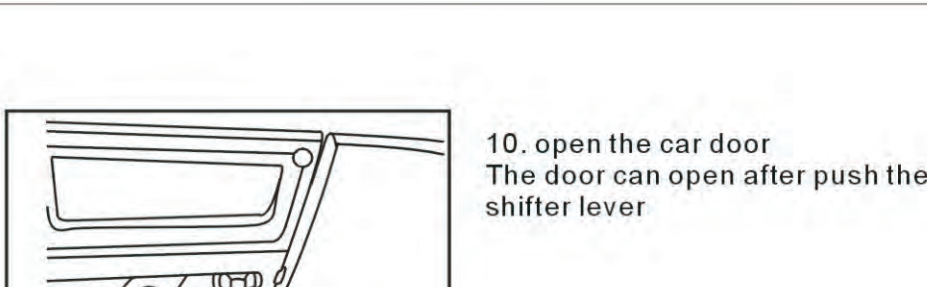

10. open the car door
The door can open after push the shifter lever

Warning. Not to be used in traffic.
⚠ WARNING:
Must be assembled by an adult.

GIVE SAFETY EDUCATION BEFORE USE

1. Can't avoid harmed by the little spare parts, less than 3years old can't drive.
2. Assembled and charged by adult for 3.
3. The max loading is 30kgs, suitable for 3-8years old children. Do not over loading for safety.
4. This product is not traffic tool, keep driving on hard and flat ground.
5. Do not drive in the dangerous place, like street, road or sloap.
6. Do not drive the mire or uneven places.
7. Children should be instructed to the correct operation, to prevent the damage caused by improper operation, accident
8. When change gears, release the foot switch, after the car stopped.
9. When driving, adult care and supervision is necessary, Do not leave and keep your child in your sight.
10. Do not let the product in rain or other ways touch water, avoide damage the circuit and motor.
11. Check whether the charger, plug-ins, and other parts are in good condition and well connected in time.
12. To make sure safety and use longer, avoide damage the charger, battery or system, must be use the originals.
13. When stop using the car, cut off the power, turn all buttons to "stop" or "off".
14. The charger and battery of the products are not toy, forbidden.
15. Do not use the spare parts not supply rom us.
16. The product mainly use PP, safety use tiome is 2years.

-6-