

Safe use of rules

Must be assembled by adults on the local assembly, please check whether the device and circuit assembly assembly process correctly.

Default of banned in the streets, highways, landslides and other dangerous places.

Children must be under the custody of adult use.

When used on the local, please do not casually change device.

When use, shall not be frequently switch forward backward function.

Please check the battery, line, plugs, and other parts for damage and found damaged, please stop using in time,

Until the restored can be reused.

“non-rechargeable batteries are not to be recharged”

Should be in the right electrode in the battery.

Run out of battery should be removed from the toy.

The power terminals shall not be short

Charging matters needing attention

1, using electric vehicles for the first time to charge first! Charging in car tail, charging charging Cover first then put the plug in the charging socket, then the charger plugged in. (charging must Be made into do, do not let your children's access to power supply)

2, please recharge immediately when electric vehicle driving speed slowed significantly, continuous Charging 8 to 10 hours, not more than 10 small at the right time.

3, in the process of charging the charger or battery have fever phenomenon (under 60 °) are Normal.

4, the electric car must use local car equipped with dedicated charger and battery, so as not to Damage the charger and battery and electric circuit.

5, the electric vehicle charging shall not do any operation.

6, please a mixture of old and new or different types of batteries.

7, electric vehicle charging, please check whether the circuit connection is correct.

8, when the electric conductor time when not in use, must charge at least once every month.

Warning: electric car used in non private places, may lead to drowning, burns, falls and other hazards.

ELECTRIC CAR

Install and use the manual

Manual has an important information, read, please keep for future reference.

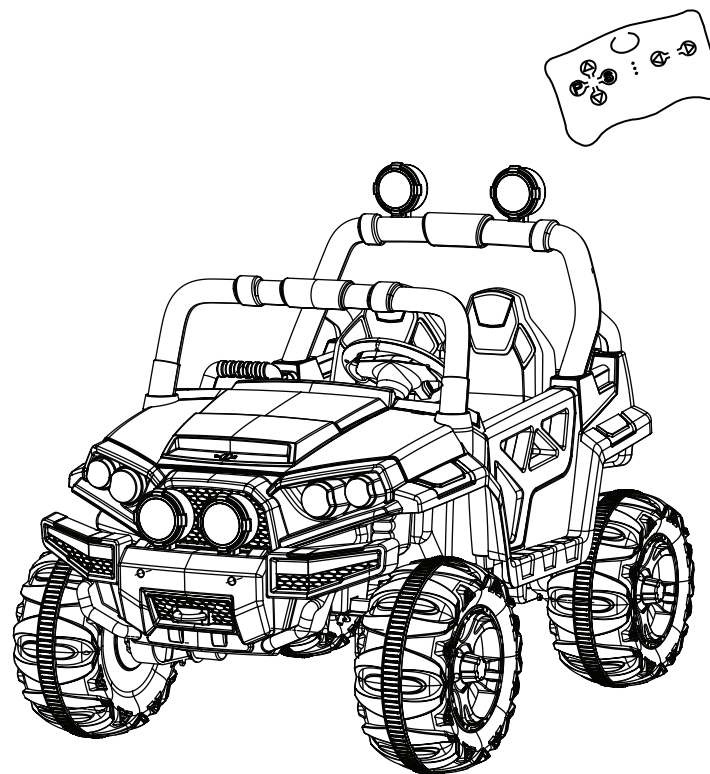

LEAN CARS

STANDARDS:EN71、EN62115

WWW.LEANTOYS.PL

- 1.Non rechargeable battery can not be charged
- 2.Power supply terminals shall not be short connected
- 3.Rechargeable batteries can only be charged under adult guardianship
- 4.Different types of batteries or do not mix old and new batteries
- 5.The battery should be put in the correct electrode
- 6.The exhausted battery should be removed from the toy
- 7.The charging battery should be taken out from the toy before charging
- 8.Contains small parts,not suitable for children under the age of 3 to use
- 9.Products should be properly assembled by the adults and then use
- 10.Please do not use in the streets roads landslides and other dangerous places must be used under adult guardianship

Cannot be used in rainy days.

Can not use water to clean.

Assembly by an adult.”

Protective equipment should be worn. Not to be used in traffic.”

Warning.This toy is unsuitable for children under 3 years due to its maximum speed

 Using The Matters Needing Attention

Products should be assembled by adult right before use.

Battery charging should be carried out by adults, must first be charged before using this product.

The first use of electric vehicles, must ensure that the battery full 10 hours! Otherwise it would be permanent damage

Pool and beyond repair.

Please don't in the street, the road, landslides and other dangerous places, and be sure to use under adult supervision.

This product is limited to a person, do not overload, the largest capacity of 30 kg.

Please fasten your seat belt, and make sure that your baby is always sat on the bench, at the same time, please do not let the baby in

Runtime stand or do some dangerous action.

Please don't suddenly change in the process of electric vehicles run forward/backward switch.

To prevent collisions with valuables, please do not use in a relatively narrow space, in order to avoid damage to electric vehicles.

Please check the product and the charger, check the wires, plugs, shell packaging and other components

Damaged, found that the damage should stop using, to be repaired before use.

When not in use for a long time, please turn the power off and remove the battery connector.

Children must use under adult supervision.

Safe use period: three years.

Please do not use in the streets, roads, landslides and other dangerous places, and must be used under adult guardianship.

The toy should be used with caution since skill is required to avoid falls or collisions causing injury to the user or third parties.

20. Exhausted batteries are to be removed from the toy.
21. The supply terminals are not to be short-circuited.
22. Products should be properly assembled by the adults and then use.
23. Please do not use in the streets, roads, landslides and other dangerous places, must be used under adult guardianship.

DECLARATION:

- 1) Manual used in illustrations to explain the product of the operations and products, with the installation of structure in the existence of a small difference in kind, please standard the object.
- 2) In order to improve product quality, not to notice, we may change the part of the structure, and appearance. please forgive.
- 3) This package contains important information that must be to keep.
- 4) Cannot be used in rainy days.
- 5) Can not use water to clean.
- 6) Assembly by an adult."
- 7) "Warning. Protective equipment should be worn. Not to be used in traffic."
- 8) Toy operation requires a certain technology, should be more careful when used, lest collision and fall lead to injury and injury to others.

Use the product please first read instructions, it will tell you the correct methods of operation and installation instructions. To avoid not correct methods of operation of this product damage or injury and your baby. Manual should be placed to take good care of.
It's STANDARD NO.: EN71 EN62115 ASTM F963

The product to get c is the main ingredients of the important parts.

SPECIFICATION

Battery	12*7VAH 12V10AH
Motor	12V35W、12V15W
Charger	Input: AC220V-240V、50HZ-60HZ, Output: DC12V1A
Maxmium load	30 KG
Work Time	Recharge 8-12h, Use for 1-2h
Speed	3-5 KM/H
Age	37 months - 95months
R/C Battery	AAA 1.5V * 2
R/C Distance	15 ± 5M

SAFE RULES

Warning Non-transportation, must be care of adult!
Before using the child for education, safety!

1. Be charged by an adult, don't let the children touch.
2. Driving, we must by adults, and the tutelage use.
3. Clamp down on the streets, roads, slope, waiting for over a backward, to eliminate obstacles to ride.
4. It's suitable for children for about 37-96 months.
5. Cycle shall not leave the seat to prevent operation resulting in injury.
6. In the car was pulled, the device, such as a block, please immediately release switch to eliminate the obstacles and foot before you ride.

LEAN CARS

UNIT MOUNT

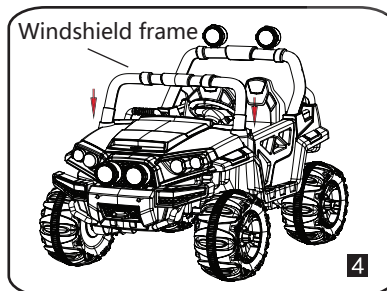

Install the windshield frame
First remove the windshield frame, then align the windshield frame clamping angle with the body clamping groove, and press down hard to hear the click sound, which indicates that the windshield frame is installed in place.
(As shown in figure 4)

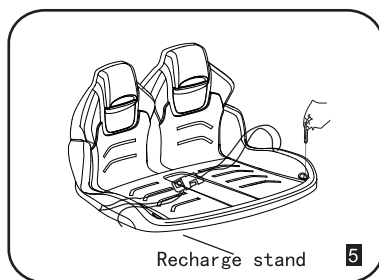

Install the seat and power connection
Before installing the seat, first align the seat chute with the body chute, and then push the seat chute inward to the appropriate position along the chute direction. If the position distance is not appropriate, adjust the hook below the seat to move the seat back and forth. The battery is positioned below the engine cover, the engine cover is opened to connect the power cord with the battery red to red to black, and the charger is inserted into the charging hole during charging, so that the whole vehicle has no function during charging.
(As shown in figure 4)

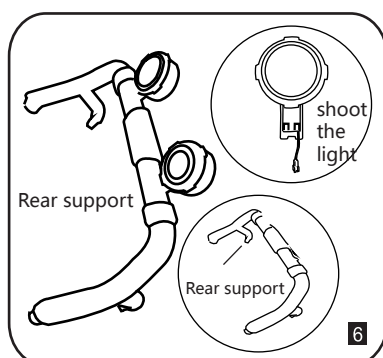

Install rear spotlights and supports
First distinguish the bracket support left and right, and then insert the support corresponding to the bracket, then spot lamp connector docking, put the wire and plug into the spot lamp slot, and then the spot lamp on the bracket slot force down, finally with four ST 4.0 * 16 big flat head tapping screw lock, respectively, the same installation left and right.
(As shown in figure 6)

Install know that

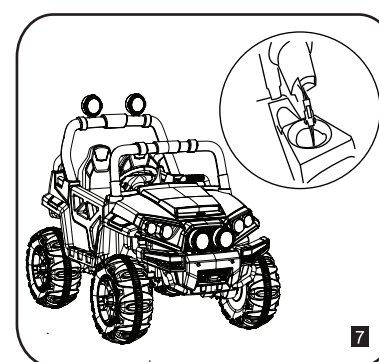

Install the rear spotlamp bracket
First, connect the connector on the assembled rear bracket with the plug-in on the vehicle body, then put the wire and plug-in into the hole, and then align the rear spotlights with the vehicle body card slot, with a total of 4 card slots at the front, rear, left and right, and press down hard to hear the click sound, which indicates that it is installed in place.
(As shown in figure 7)

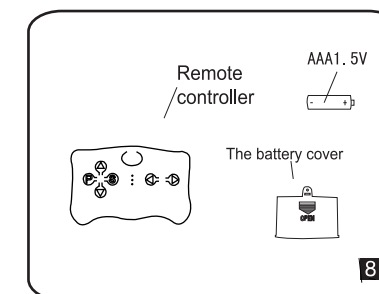

Remote control battery installation
First use the screwdriver to unscrew the screw on the battery cover, then take out the battery cover and remote control into two AAA1.5 V batteries, and battery cover cover and screw locking.
(As shown in figure 8)

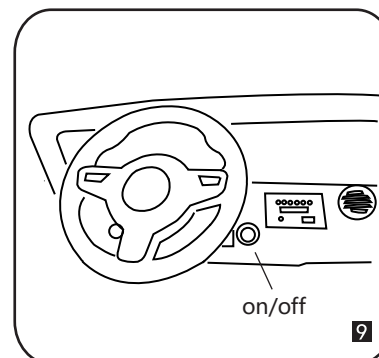

Instruction manual for steam car
1, open the power supply, there is a start sound, sound and light start on the instrument, display voltage.
2, forward and backward switch in the "forward" or "backward" position, step on the foot switch, the car forward or backward operation.
3, high and low speed switch in the "high speed" position, the car is in high speed running state; The high and low speed switch is placed in the "low speed" position and the vehicle is running at low speed.
4, open the independent light switch, vehicle lights up; Turn off the light switch and the whole vehicle lights will go out.

CHARGE METHOD

1. First to use please open the cushion, and the battery connections with main distributing frame, with red in red and black in black, not a line ends meet, or cause a short-circuit.
2. Charging socket the cushion down side, and needs recharging. charger plug in the outlet, then insert the power outlet.
3. The train slowly, in charge, the time for 8-10 hours, and not more than ten hours.
4. In the first to use the deposit, we must ensure that the cell battery up to 10 hours. otherwise, permanent damage cells and beyond repair.
5. Charging devices or battery which has a fever (60 °C) are normal.
6. The electric baby must use this car is equipped with the charger and the battery, in the case of broken the cell phone chargers and the counter-voltage or an electric circuit.
7. Have to recharge the batteries to be recharged from the toy the use of battery.
8. Not mixed with the old and new or different types of batteries.
9. Can't insert the battery wire connector.
10. When the baby is not use for a long time, at least once every month to charge.
11. Toys can't connect to the surplus on the use of the recommended amount.
12. When the car is charging, can't use it.

PACKING LIST

★ Car body (polypropylene)	1PC	★ Charger	1PC
★ The steering wheel	1PC	★ MP3 connector	1PC
★ Chair	1PC	★ Manual	1PC
★ Car wheel, blocks	4PCS	★ Remote controller	1PC

USE CAUTIONS

1. In the first to use the deposit, we must ensure that the cell battery up to 10 hours. otherwise, permanent damage cells and beyond repair.
2. In the streets, roads, slope, ditch and the danger area.
3. Please don't on the polished surface, such as marble, tile on the surface.
4. This product by one, not limit, the greatest relief to over 30KG.
5. Don't run in an electric switch on deposit in the back of the light switch.
6. Shall not be altered the car circuit or device to additional charged
7. The remote control and not to let it get caught in the rain or otherwise made in water and keep away from sources of ignition to avoid causing the damage.
8. Met with obstruction, the baby stop, please leave the obstacles to ride.
9. Don't use in the water, water and other liquids in the car.
10. Not in use, to avoid hitting the child.
11. When the remote control battery power is low, the car on the remote control and turned back, a short distance, shake, please replace the battery!
12. Not in use, please turn off the switch. no, please unplug the battery, a connector.
13. Different types of batteries or do not mix old and new batteries
14. The battery should be put in the correct electrode
15. Non-rechargeable batteries are not to be recharged.
16. "Batteries are only to be charged by adults or by children at least 8 years old"
17. Rechargeable batteries are to be removed from the toy before being charged.
18. Different types of batteries or new and used batteries are not to be mixed.
19. Batteries are to be inserted with the correct polarity.

LEAN CARS

TROUBLESHOOTING

PROBLEM	ANALYZE	SOLUTION
Car doesn't work	• Low power	Recharge the battery
	• Damage of thermic fuse	Change with new thermic fuse
	• Lose of wheel nut	Use new nut
	• Loose of battery connector	Put on the connector
	• Exhaust & bad battery	Change with new battery
	• Damage on electrical parts	Go to repair shop
	• Damage on motor	Go to repair shop
Battery can't be recharged	• Loose of the battery connector	Tighten the connector
	• Charger doesn't plug the power	Plug charger with power
	• Damage of charger	Change new charger
Short of run time	• Battery with lower power	Recharge the battery fully
	• Battery is old	Change new battery
Noise & Heat during recharge	• It's chemical process	It's normal & safety
Low Speed	• Old battery	Use new battery
	• Low power	Recharge the battery fully
	• Over burden	Reduce burden under 25KG
	• Run on not-flat ground	Run on flat ground
Noise of gear box	• Damage of gear box	Go to repair shop
	• Damage on motor	Go to repair shop
Car shake when running	• Bad connect of motor wire	Reconnect the wire
	• Motor doesn't work well	Go to repair shop
No sound & light when running	• Loose of sound & light wire	Connect the wire
	• Damage of sound & light board	Go to repair shop
Car can't stop in run	• Damage of electrical parts	Go to repair shop
	• Remote control battery exhaust	Change battery
Unusual working condition under Remote control	• Remote control out of distance	Keep near distance between car and remote control
	• Damage of remote control	Damage of remote control
	• Damage of receiver board	Change receiver board
	• Disturb of magnetic filed	Far away from magnetic filed

Install the front wheel

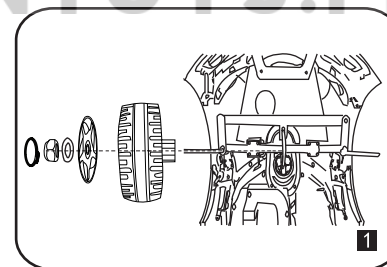

First put the front wheel iron frame into the car body clamping groove, then use 8 ST 4.0 * 16 big flat head to fix it, and then put the direction rod into the steering link hole. Then that gasket, the wheel, the wheel cov and the gasket are respectively arranged on the front shaft sleeve and then are loc by using a locknut, and the wheel cover is covered. Left and right installation is the same (As shown in figure 1)

Install the rear wheel

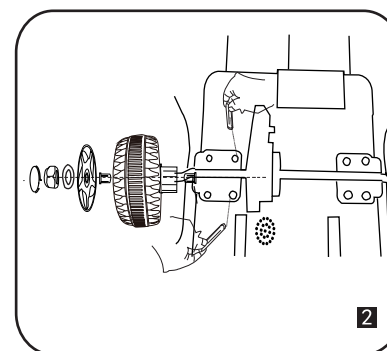

Firstly, the vehicle body is turned over, then the damping spring and the flat gasket are put into the vehicle body hole, then the rear shaft is put on the upper surface, the rear shaft fixing piece is pressed on, and the rear shaft fixing piece is fixed on the vehicle body by using eight ST 4.0 * 16 self-tapping screws, and then the drive gear box, the wheel, the wheel cover, the gasket and the rear shaft are respectively sleeved on the rear shaft, finally, the rear shaft is locked by using the anti-loosening nut, and the wheel cap is covered. Left and right installation is the same. (As shown in figure 2)

Install the steering wheel

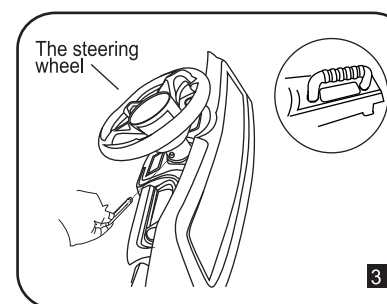

Will line connectors and direction in the direction of dish stem line connectors are connected (note that connect the positive and negative). Then put the steering wheel in the direction of the pole, with the M5 inner hexangular set screw rod through the steering wheel and direction in turn. (as shown in figure 3)