

## ELECTRIC BUGGIES

<b>Qualification certificate</b>	Production date:
	Checker:

- The diagrams in this manual are used to illustrate the operating method and the structure of this product, and there may be some difference between the practicality and the diagrams, and the practicality shall prevail.
- In order to improve the quality of the product, we may change some parts of the structure of the product or its appearance without notice in advance, which need your understanding.
- This manual contains important information and it must be well kept.



## USE AND INSTALL INSTRUCTIONS

Applicable age range: 36-72 months  
Maximum weight of 25 kg  
Assembly and each charge must be completed by the adult  
Please read the instructions carefully before using  
The instructions contain important information. Please keep them for future reference  
It is recommended to charge 4-6 hours before use  
Use under adult supervision, cannot drive on the road

## A ABOUT THE PRODUCT

Thank you for choosing baby tiger, electric buggies!

Baby tiger is always striving for excellence, constantly designing children's electric toys for comfort and safety, and accompanying your children to a lively and happy childhood.

Before using a very important thing is to carefully read the product manual, it can tell you detailed installation procedures and the correct method of use, it can also guide you to avoid improper operation and damage to the product or rider, particularly important is that it can tell you a lot of security considerations, please put these content, memorizing and guide your child to use.

Please keep the instructions properly and put them in easy access.

## B PARAMETER SPECIFICATION

Applicable age	36-72 months	Load limit	25 KGS
Storage battery	6 v 4.5AHx1 single drive 12 v 4.5AHx1 dual drive	External dimension	110 x67x46cm
Charging time	8-12 hours	speed	4.2 KM/H
charger	Input AC110/220V Output DC6V500MA/ 12 v / 700 ma	The power supply mode	plug-in

## C NEED TO KNOW BEFORE INSTALLATION



### Warning

Please timely pack the bag to avoid the child play and cause suffocation!



- Small parts are not suitable for children under 36 months.
- Products may contain potentially dangerous sharp edges or sharp tips before assembly, so the products must be assembled by adults.
- Tools for installation: screwdriver (self - provided), wrench (placed in part package).
- Small parts have a choking danger, no children touch play!
- Please check the quantity of all the parts before installation, the packaging plastic bags of the products, please properly handle, strictly prohibit the children to play, have suffocate danger!
- Please check whether the wire, plug, shell and other parts of the charger are damaged before charging. If there is any damage, please stop using it until it is in good condition again!

## K troubleshooting

Trouble type	How to check it	How to remove it
The motor doesn't work.	1. Is it caused by the overload protector?	If yes, the vehicle is overloaded or operated improperly and the overload protector has cut off the power automatically.
	2. Is the foot switch well connected?	If no, repair the foot switch; If yes, see the next item.
	3. Are the wires welded well on the ends of the motor?	If no, weld the ends well; If yes, see the next item.
	4. Are the wire connectors of the motor well connected?	If no, connect the connectors well; If yes, see the next item.
The vehicle cannot move forward or backward.	1. Check the forward/backward switch with a multi meter and see if it is normal.	If no, change the forward/backward switch with a new one; If yes, see the next item.
	2. Are the driving circuitry and the forward/backward switch well connected?	If no, connect the wires well; If yes, there is something wrong with the driving circuitry board, thus, contact the supplier.
The vehicle moves slowly.	1. Is the voltage of the accumulator over 6V/12V?	If no, charge the accumulator; If yes, see the next item.
	2. Will the vehicle move faster when the motor (gear case) is connected directly with the accumulator?	If yes, there is something wrong with the driving circuitry board, thus, contact the supplier; If no, see the next item.
The accumulator cannot be charged.	1. Are the connectors of the accumulator loosened or dropped?	If yes, connect the connectors well; If no, see the next item.
	2. Does the charger become a little warmer while it is being charged?	If no, the charger is damaged; if yes, the accumulator is damaged.
The vehicle is normal except that there is no sound or light.	1. Is the sound and light switch in good condition?	If no, the switch is damaged; If yes, see the next item.
	2. Check the wires and connectors from the head to the accumulator and see if they are in good condition.	If no, well connect the connectors.
Wheels doesn't work	1. Can the driving wheel turn?	If yes, let the wheels touch the ground; If no, see the next item.
	2. Check and see if the gear wheels in the gearcase are damaged?	If yes, change the gear case with a new one.
The vehicle often stops while it is moving.	1. Is the vehicle overloaded?	If yes, nothing is wrong with the vehicle; If no, see the next item.
	2. Is the surface where the vehicle is running on even ?	If no, drive it on even surfaces; If yes, see the next item.
	3. Can the free wheels be turned freely?	If no, repair the wheels or the axles.

When customers don't have the conditions to apply the above mentioned trouble shooting methods, please contact our agent or supplier.

## I The fuse

This product is equipped with a self reset the fuse when overload or not at that time, use the reset the fuse will automatically cut off the power supply for 15 to 20 seconds, and then restart the connection, since the restoration of the fuse installation on the local here under the mat

In order to avoid the fuse cut off the power

This product cannot overload, the maximum load weight is 25KGS

Don't drag and drop anything behind this product

Do not allow any other liquid to be dipped into the circuit, battery, etc

Do not change the wiring system of this product without authorization

## J Maintenance and maintenance

- The former parent should check whether the main parts are intact, the battery, the charger, the wire, the plug, the shell and other parts are damaged. Whether the screw is loose; If there is any potential safety hazard, you should stop using it until it is damaged.
- Use a small amount of lubricating oil to lubricate the iron parts of the vehicle for a period of time to prevent wear and rust.
- The vehicle should be placed away from the source of fire and avoid long term lighting. In wet weather, the car should be kept indoors or covered with a tarp
- Models should stay away from hot objects such as stoves and heaters, and the plastic parts may melt. When charging, stay away from flammable items to prevent fire from happening
- Please charge after use, charging must be operated by adult. If you don't have to recharge your batteries for a long time, then charge them at least once a month to extend the battery life
- Wipe the vehicle with a dry soft cloth. Also can use non-waxy furniture to replace soft cloth to wipe plastic parts, to achieve surface finish effect. Do not use chemical solvents to wipe the plastic parts of your toys. Do not wash vehicles with soap and water. Do not drive in rain or snow. Water will damage the motor. Circuit systems and batteries for vehicles
- When the product is not used or placed, please cut off the power of the product, and all switches will be switched to the stop or off position
- Do not use fuses that do not conform to the specifications of this product
- Do not change the structure and line system of this product without authorization. The maintenance work must be conducted by professional or under the guidance of technical personnel

## D PARTS LIST AND BREAKDOWN DIAGRAM

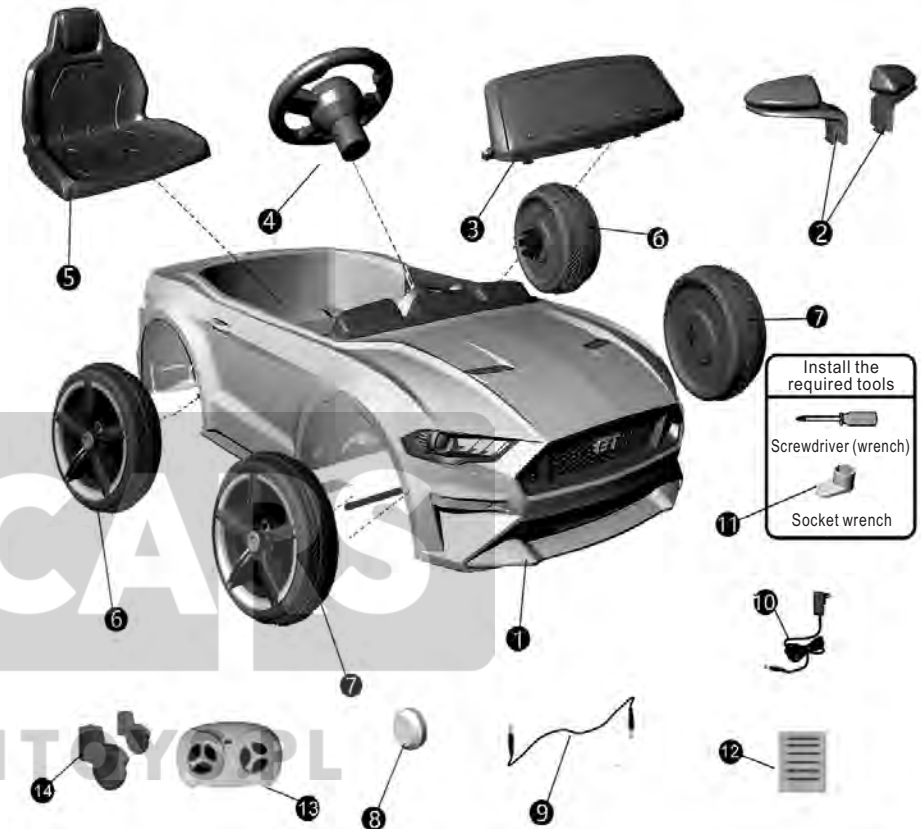

Ordinal number	Part name	quantity	Ordinal number	Part name	quantity
1	Car body	1	8	Wheel core cover	4
2	mirror	1	9	MP3 conductor	1
3	The windshield	1	10	charger	1
4	The steering wheel	1	11	Plastic wrench	2
5	seat	1	12	Instruction book	1
6	Rear wheel (with clubs)	2	13	Remote transmitter	1
7	Front wheel (without clubs)	2	14	Training wheels	2

## E INSTALLATION STEPS

### 1. Install the auxiliary wheel

To turn the body, remove the screw from the rear end of the body, and hold the auxiliary wheel in a screw.

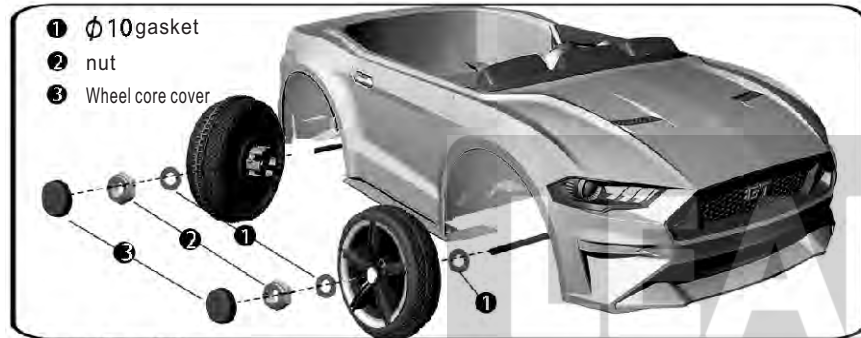
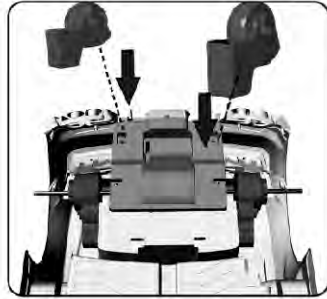

### 2. Installation of wheels

First remove the gasket and nut on the axle

Install front wheel: add a 10 - diameter spacer on the front axle, install the front wheel (choose not to bring the plum flower), and then add a washer with a diameter of 10 to fix the core cover with nuts

Install the rear wheel: install the rear wheel (choose the plum) to the rear axle  
Add a spacer with a diameter of 10, and fix with nut to cover the core cover

### 3. Install the steering wheel

First remove the screw from the steering wheel

Docking steering wheel connected line plug-in again, before put the steering wheel steering rod should be docking good plug-in to match below the perforation, combined with the steering wheel, alignment direction (distinguish) before and after, through the screw with nut.

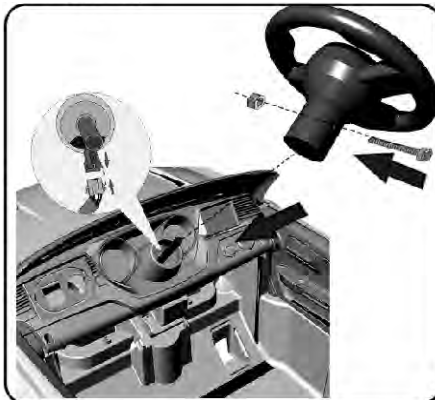

3

## H Charging schematic

This product is equipped with charging protection function. When charging, all functions of the car cannot be used

Charging must be done by adults! The charger and battery can not be touched by children

The power switch must be turned off when charging

Charge 4-6 hours before using the first one, but not more than 10 hours  
When the normal speed of the vehicle slows significantly, indicating that the battery is not enough, please timely recharge

Please charge 8-12 hours after each use, but no more than 20 hours

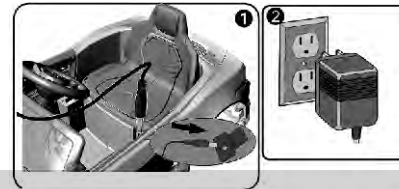

1. Insert the charger plug into the body charging hole, located under the seat
2. Plug the charger into the power socket



## Warning!

Prevent fire and shock

- Using only the chargers and power sources specified by the manufacturer, it is forbidden to use other brands of chargers and power sources, otherwise there may be fire and explosion
- Do not use the charger and battery in other products, otherwise overheating can lead to fire and explosion
- Do not change the line structure of the product without authorization, otherwise it may cause fire and explosion, and can cause permanent damage to the product
- Do not use a tool connection between the positive and negative poles of the battery, or there may be fire and explosion  
Always keep the battery dry. Do not expose it to fresh water
- When charged, the battery produces harmful gases and has a pungent smell. It is strictly prohibited to smoke in the vicinity of the rechargeable storage battery.
- No flame or spark is allowed to cause an explosion or other accidents
- The vehicle must be charged in a well-ventilated and dry area
- Do not open the battery and charger
- Do not reverse the bottle
- Please check the charger before charging, the battery and the plug are damaged. If there is any damage, you should stop using it until the repair is done
- It is normal for the battery to heat up during the charging process, but it should be checked and charged when the temperature is too high
- Whether the current is in or out of the battery
- A power supply must be fixed with a pressure plate. If the car is overturned, the battery may cause damage to the child
- If the product is stored or not used for a long time, it must be charged and charged once a month to ensure the life of the battery
- Chargers and batteries are not toys and children are not allowed to play

8

# G

## Operation schematic



**Attention!**  
When changing gear, make sure that the vehicle has been completely stopped to avoid damaging gear boxes and motors

### Power switch:

Turn on and off the vehicle power supply  
Go forward

1. Move forward/back switch to advance position  
Step 2 gently step on the foot switch and the vehicle will move forward  
back

Move forward backward switch to back position  
Step 2 gently step on the foot switch and the vehicle will move backwards  
stop

Lift the foot off the pedal switch and the car will stop slowly  
music

Press the music button on the steering wheel to make music  
Function of remote control

Turn on the total power of the car and use the remote control to make the vehicle move forward/backward, left/right

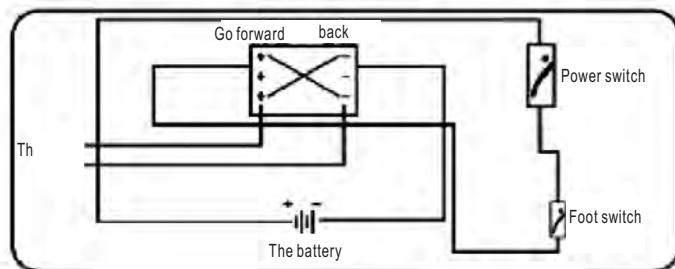

# E

## INSTALLATION STEPS

### 4. Install windshield

The screws that install windshield are fixed on large body, need to be unloaded first, install windscreen, end with screw to fasten again.



### 5. Install the reflector

Insert the mirror directly into the body.

### 6. Safety seat

First, loosen the screw holding installation on the car seat cushion secondly according to the color is good for the remote control receiving box above connection line, installed after the seat, the seat with screw on both ends of the seat is fixed to the body

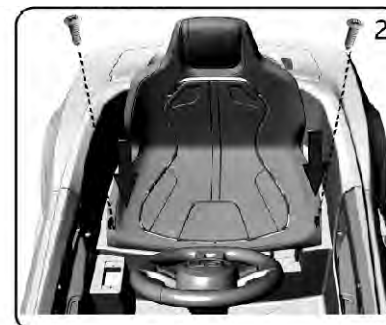

## E INSTALLATION STEPS

The whole vehicle assembling is finished now. Check and see if there is anything left uninstalled; check and see if the functions of the product are normal; charge the product with the charger supplied in time.



- 1, first remove the battery cover on the remote control, in the section 2 batteries in the right way.
- 2, for the first time to use the code, this product has the memory function, after replacing the battery without having to code.

3, the code steps:

Long press to code for 3 to 5 seconds, until the LED lights flashing, open the power supply buggies, LED lights into long, the code is successful,

See note on the back of the remote control to use.

### Warning:

**The remote control is not a toy, should be used by adults, children can not touch play.**

### Disclaimer:

**The remote control pattern is for reference only, please refer to the object.**

## F Need to know before use

**Before using, you must confirm that the following work has been completed:**

Step described in accordance with the instructions to complete the installation of the vehicle, the accumulator plug-in has been good, the power supply has been switched on, the location of the screws to ensure all need have lock, check whether the product function is normal.

### Important!

Before the first use, the battery should be charged at least 4-6 hours, not more than 10 hours, and the charge can only be operated by the adult.

## F Need to know before use

### warning!

#### To prevent accidents:

- When driving a vehicle, it must be supervised and supervised by an adult or parent, and the caregiver must not leave, please ensure that your child is in your field of vision.
- It is prohibited to drive vehicles in non-safe areas such as roads, vehicles and steps
- Shoes must be worn when driving a vehicle
- You should sit in your seat while driving
- Age range: 36 to 72 months, maximum load of 25 kg

#### Safety warning

Please tell your child and his playmates the following safety rules and make sure they understand!

- The vehicle must be under adult supervision
- Protective helmets should be worn when driving
- Shoes must be worn when driving
- When driving a vehicle, you must be seated
- Make sure your child is driving in a safe driving environment, such as home, garden or playground
- Note that the vehicle is only suitable for running on hard, flat surfaces, and to ensure safety, it is prohibited to travel in the following non-safe environments
  - A trench, A river, A lawn, A slope or A bumpy surface
  - B road or other vehicles driving, walking places
  - C could hit an obstacle that can cause harm
  - D other non-safe areas
- Avoid driving in the dark. Children do not deal with unexpected obstacles or accidents. Only in daylight or in a bright area
- Do not use this product when it is raining or snowing
- When changing gear, make sure that the vehicle has been stopped moving
- Please confirm that the user of this product meets the applicable age range of this product and shall not exceed the maximum capacity
- Do not change the structure and wiring system of the product without authorization
- Regularly check whether the wire plug of the vehicle is aged or missing
- To avoid accidents, make sure the vehicle is safe before driving
- Please do not permit any child to approach the driving vehicle. Do not allow the child to touch the wheel



#### Battery safety warning

**Non-rechargeable batteries cannot be charged**

**Rechargeable batteries can only be charged under adult supervision**

**Rechargeable batteries should be removed from the toy before charging**

**Different types of batteries or old and new batteries do not mix**

**The battery should be placed in the correct polarity**

**The exhausted battery should be removed from the toy**

**The power terminal shall not short circuit**