

# CHILDREN'S ELECTRONIC TOY CAR



LEAN CARS

WWW.LEANTOYS.PL

Important	Warning!
Age: 3 Years + Maximum user weight : 25 Kg	<ol style="list-style-type: none"><li>1. Not Suitable for children under 36 months. Choking hazard due to small parts</li><li>2. For family and domestic use only</li><li>3. Not to be used in traffic</li><li>4. Adult assembly required</li><li>5. Warning! Protective equipment should be worn</li><li>6. This toy has no brake</li><li>7. This toy is unsuitable for children under 3 years due to its maximum speed.</li><li>8. This toy contains batteries that are non-replaceable</li><li>9. It has the potential hazards of using the ride-on electric toys in areas other than private grounds</li></ol>

## OWNER'S MANUAL

**Read and understand this entire manual before using!**

Please keep this manual for future reference as it contains important information. Before first time use, charge the battery for at least 8-12 hours, no more than 20 hours.

# Table of Contents

<b>1. About Your New Vehicle</b> .....	Page2
<b>2. Parts List</b> .....	Page3
<b>3. Parts Diagram</b> .....	Page4
<b>4. Assembly Steps</b> .....	Page5-7
<b>5. How To Operate Your Vehicle</b> .....	Page8-12
<b>6. Charging The Vehicle</b> .....	Page13
<b>7. Troubleshooting Guide</b> .....	Page14
<b>8. Maintaining Your Vehicle</b> .....	Page15
<b>9. Disposal Of Battery</b> .....	Page16

## About Your New Vehicle

Thank you for purchasing our products, we want your child to enjoy this product for years to come. Keep these points in mind as you read this guide:











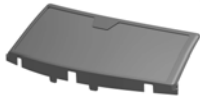





<b>Suitable age:</b>	3+ years	<b>Battery:</b>	DC 6V 4.5 AH *1 OR 12V4.5AH*1
<b>Load Capacity:</b>	Under 25Kg	<b>Product size:</b>	1050*680*500 mm
<b>Material:</b>	PP	<b>Optimum Temperature:</b>	Below 40°C
<b>Charger:</b>	Input: 100-240V, 50-60Hz	<b>Charging time:</b>	8-12 hours, at most 20 hours
	Output: 6V/8V 500mA OR 12V/15V 1000mA	<b>Fuse:</b>	F5A/6A,Self-resetting

### **WARNING!**

**FOR THE SAFETY OF YOUR CHILD, PLEASE READ ALL WARNINGS AND ASSEMBLY/USE INSTRUCTIONS. KEEP THIS GUIDE FOR FUTURE REFERENCE.**

- **ADULT ASSEMBLY REQUIRED.** The product contains small parts, which are for adult assembly only. Keep small children away when assembling.
- Always remove protective material and poly bags and dispose before assembly.

# Parts List

PART NO	PART NAME	PICTURE	Qty (pcs)	REMARKS	PART NO	PART NAME	PICTURE	Qty (pcs)	REMARKS
1	Vehicle body		1		2	Windshield		1	
3	Seat		1	The screw is on it.	4	Gear box		1 or 2	Installed on the vehicle body.
5	wheel		2	The same Wheel	6	Driving Wheel		2	The same Driving wheel
7	Steering wheel		1		8	Rearview mirror		1	Left & Right
9	M4X20 bolt		2	Placed on the body	10	Wheel hub		4	Stuck on the wheel
11	Specification		1		12	M5X40 bolt +M5 Nut		1	Placed on the steering wheel
13	MP3 Line		1		14	Charger		1	
15	training wheel		1		16	Remote control		1	
	M10 washer		3						





# Parts Diagram

**NOTE:** Some Parts Shown are assembled on both sides of vehicle



PART NO	PART NAME	Qty (pcs)
1	Vehicle body	1
2	Windshield	1
3	seat	1
4	Gear box	1 or 2
5	Driving wheel	2
6	wheel	2
7	Steering wheel	1
8	Rearview mirror	1 pair
15	Training wheel	1

**Tools Required**

-  Screwdriver(not included)
-  Pliers(not included)
-  Hammer(not included)
-  Spanner( included)



# Assembly Steps

---

- Your new vehicle requires adult assembly. Please set aside at least 40 minutes for assembly. Children can be harmed by small parts, sharp edges and sharp points in the vehicle's unassembled state. Care should be taken in unpacking and assembly of the vehicle. Children should not handle parts, or help in assembly of the vehicle.
- Please identify all parts before assembly and save all packaging material until assembly is complete to ensure that no parts are discarded.
- Assembly tool for need: screwdriver(not included), pliers(not included), hammer(not included),Spanner( included).

## 1. Installation of auxiliary wheels and rear wheels

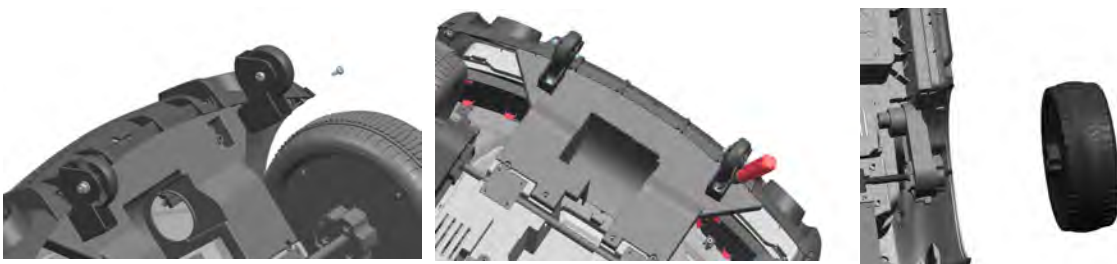

### Installation of training wheel

- Turn the car upside down.
- Remove the M4X12mm screw that has been fixed to the car body.
- Installation of training wheel.
- Then fixed with M4X12mm screw.

### Installing rear wheel

- Install a motor on the rear axle.
- Load a drive wheel on the rear axle.
- Put the wheel on the rear shaft with a little force;

**Note: the installation method of left and right drive wheels is the same**

## 2. Install the front wheel.

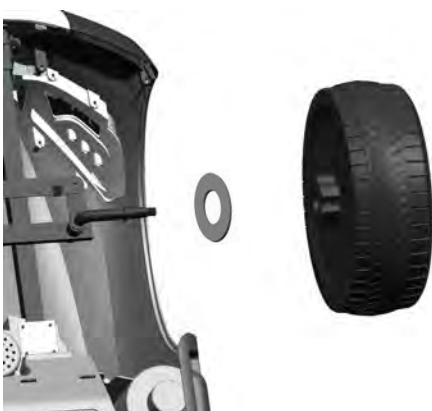

- Turn the car upside down.
- Load a 10# gasket on the rear axle
- Put the wheel on the front shaft with a little force;

**Note: the installation method of the left and right front wheels is the same.**

# Assembly Steps

---

## 3. Connect the power supply

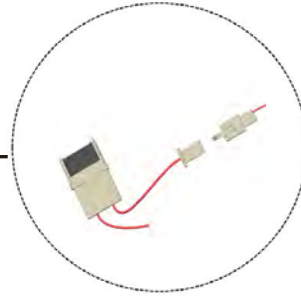
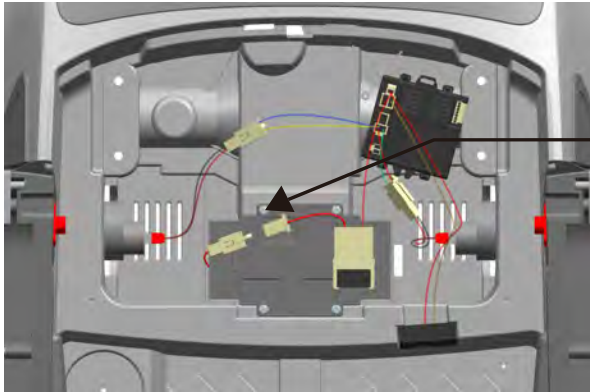

Dock the docking plug before installing the seat  
Note: power plugs cannot be operated in reverse



### Battery Safety Warning

Different types of batteries or old and new batteries can not be combined.  
Non-rechargeable batteries can not be recharged.  
Batteries can only be recharged under adult supervision.  
Rechargeable batteries should be removed from vehicle before charging.

The battery should be placed in the correct polarity.  
Exhaust batteries should be removed from vehicle.  
Power terminals must not short-circuit.  
Dry batteries are not available.

## 5. Install the seat

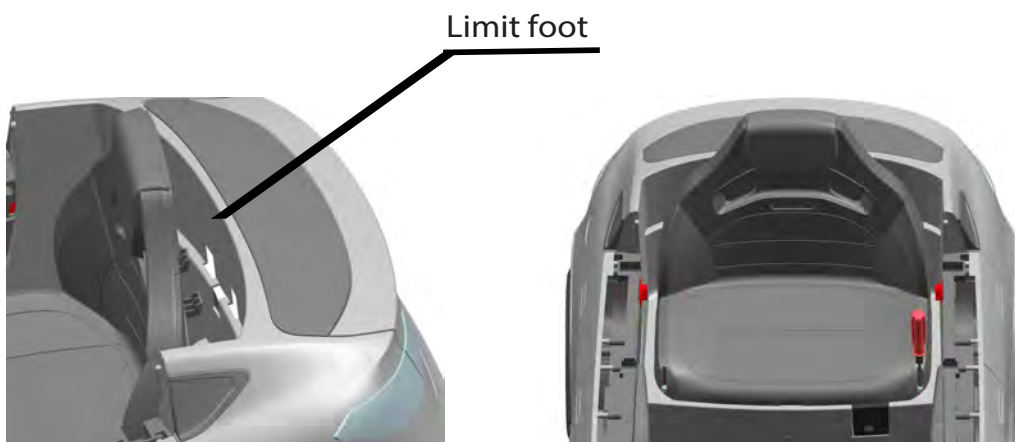

- Insert the limit foot of the back end of the seat on the car body;
- Place the seat on the car body and fix it with 2pcs **M4X20mm** screws

# Assembly Steps

---

## 6. Install the windshield

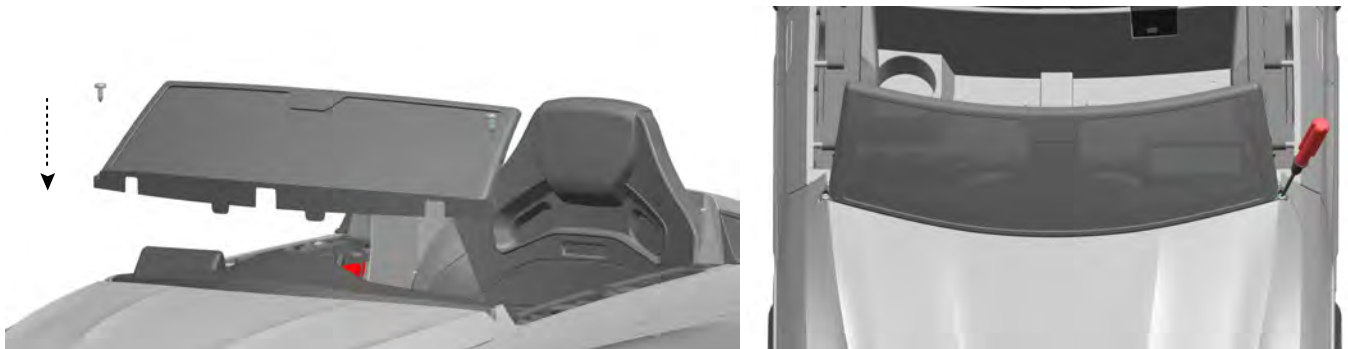

- Press the windshield into the body until installed.
- Fixed with 2PC M4X12mm screws.

## 7. Install the steering wheel



- Connect the music plug-INS on the orientation disk to the music plug-INS next to the direction bar, then place the plug-INS in the hole below the direction bar.
- Insert the steering wheel into the end of the direction bar.
- Alignment of the hole on the steering wheel with the hole on the direction bar and insertion of the M5 X 40 unit screw.

## 8. Install the rearview mirror

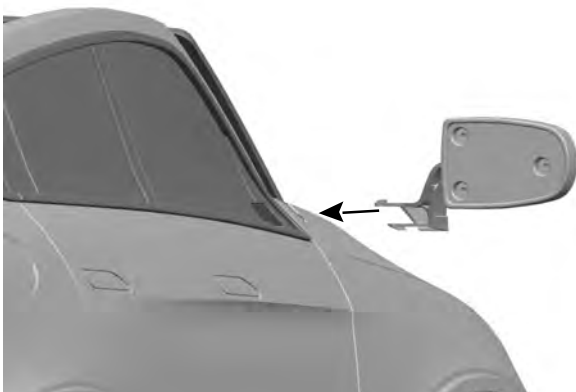

- The left and right sides of the reflecting mirror are respectively inserted on the vehicle body.

# How To Operate Your Vehicle

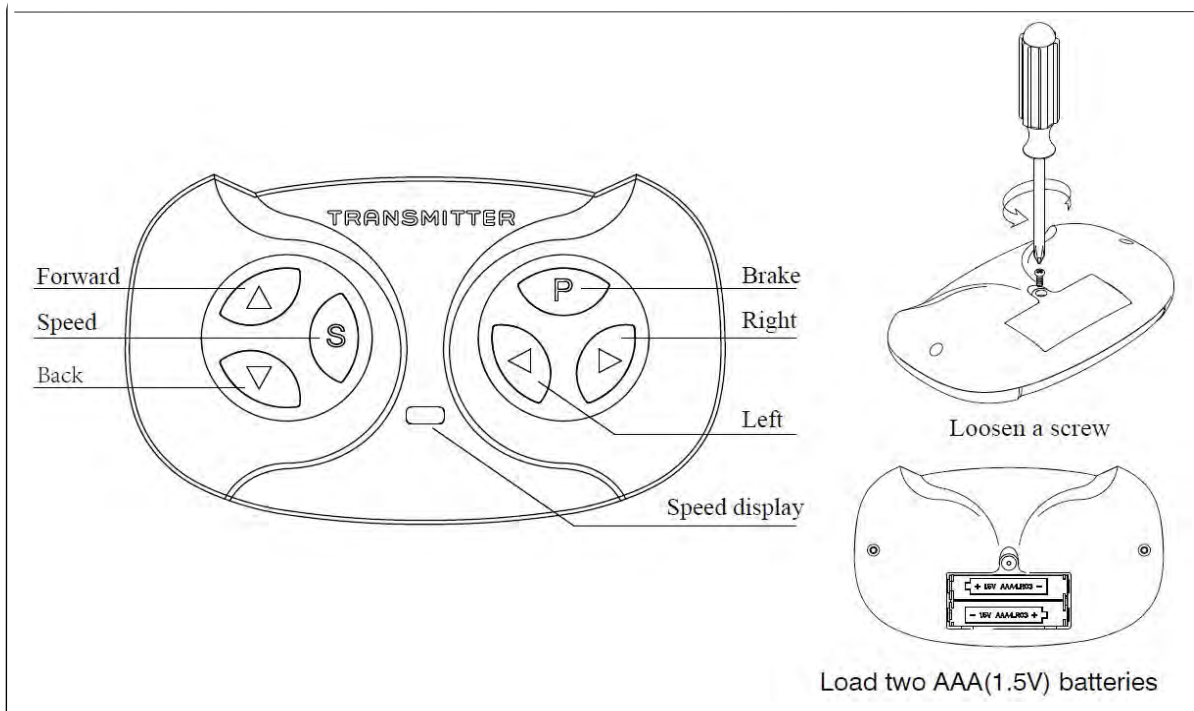

Step 1: open the battery cover on the back of the remote control and load into 2pcs AAA(1.5V) batteries; (dry batteries are not available in this product)

Step 2: turn off the main power switch on the car;

Step 3: hold down **Forward** and **Back** keys at the same time, (note that hold down at the same time) when the **Speed display** flashing, the main power switch on the car, the **Speed display** red light to stop flashing, code success;

Key description: **Speed** key for speed regulation, each time change a speed, **Speed** key on a red light for low speed, two red lights for medium speed, three red lights for high speed;

- Press button **Forward** and the car moves forward;
- Touch and press **Back** , the car back;
- Press button **Speed display** to adjust the speed of the car.
- Touch and press **Left** key . The car turns to the left.
- Touch and press **Right** and the car turns to the right;
- Brake** for the brake key, touch the car to maintain the brake state, red indicator all flashing, and then touch the brake state contact;

**Special description:** If the product has the function of code-free, the remote control installed on tow AAA (1.5v) batteries, you can use the remote control to operate the product; vice versa, according to the code operation instructions to code;

**This product may have remote control priority (depending on product configuration):** When the remote control is operated, the pedal switch of the product is invalid; when the remote control operation is stopped, the pedal switch of the product can be used.

# How To Operate Your Vehicle

---

## **WARNING!**

### **PREVENT INJURIES AND DEATHS:**

- **NEVER LEAVE CHILD UNATTENDED. DIRECT ADULT SUPERVISION IS REQUIRED.** Always keep child in view when child is in vehicle.
- Never use in roadways, near cars, on or near steep inclines or steps, swimming pools or other bodies of water.
- Always wear shoes.
- Always sit on the seat.
- Suitable for age 3<sup>+</sup> years; Maximum user weight is 25kgs.
- Not to be used in traffic .

### **Must confirm before using that following work which is already finished:**

- **Important!** Before using the vehicle for first time, the battery needs to be charged for 8 to 12 hours, no more than 20 hours. Only an adult can charge or recharge the battery.
- Finishing the complete car to assemble according to the steps that the manual described. The plug-in package of storage battery has already been inserted well, the power has already been put through.
- All places to need the screw guarantee the screw has already been locked.

### **Rules for Safe Riding**

**READ THESE RULES ALOUD TO YOUR CHILD AND THEIR PLAYMATES AND MAKE SURE THEY UNDERSTAND THEM!**

- This toy is no break. Always wear a helmet and protective clothing when riding.
- Direct Adult Supervision Required.
- Keep Children within Safe Riding Areas.
- Never driving in roadway, near motor vehicles, on lawn space, on near steep inclines or steps, swimming pools or other bodies of water.
- Use the toy only on flat surfaces. such as inside your house, garden or playground.
- Never use in the dark. A child could encounter unexpected obstacles and have an accident. Operate the vehicle only in the daytime or a well-lit area.
- It is not recommended to drive the vehicle on wet surfaces or on lopes of greater than 15 degrees.
- Do not use this vehicle outdoors when it is raining or snowing.
- Make sure you come to a complete stop before changing directions from forward to back.
- Please follow the correct weight and age limits allowed to drive this vehicle.
- It is prohibited to change the circuit or add other electric parts
- Inspect wires and connections of the vehicle periodically.
- In order to avoid accidents, please ensure the vehicle is safe before riding.
- Do not let any child touch the wheels or be near them when the car is moving .
- This vehicle has adjustable play seat belts. please instruct children how to tie the safety belt before using, guarantee the security.



# How To Operate Your Vehicle

## Use Operation(Ensure the power switch has been turned on)

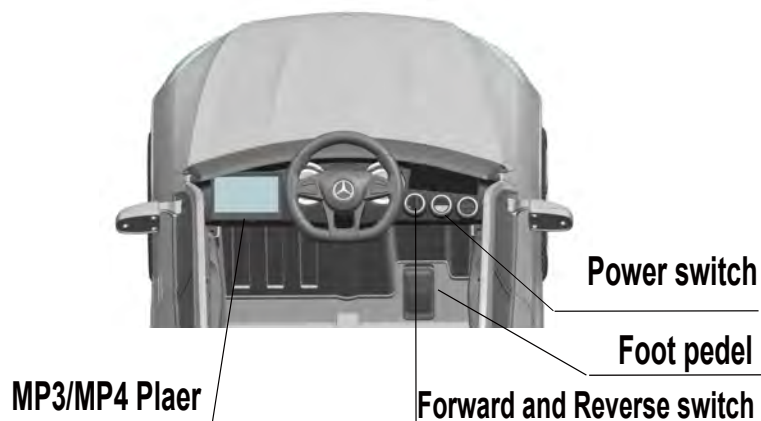

### IMPORTANT!

Always stop vehicle when changing the speed or direction to avoid damage the gear box and motor.

- (1) Turn on the general power switch first.
- (2) Forward  
Press the "Forward and Reverse switch" to the "Forward" position.  
Press the pedal.  
The vehicle drives forward.
- (3) Stop  
Remove foot from the accelerator pedal to stop the car.
- (4) Reverse  
Press the "Forward and Reverse switch" to the "Reverse" position.  
Press the pedal.  
The vehicle drives backward.



## How to operate MP4 player (Matching function)



**Note:** MP4 display is a color display touch screen, according to the icon prompt to select.



# How To Operate Your Vehicle

## (5) How to operate MP3 player

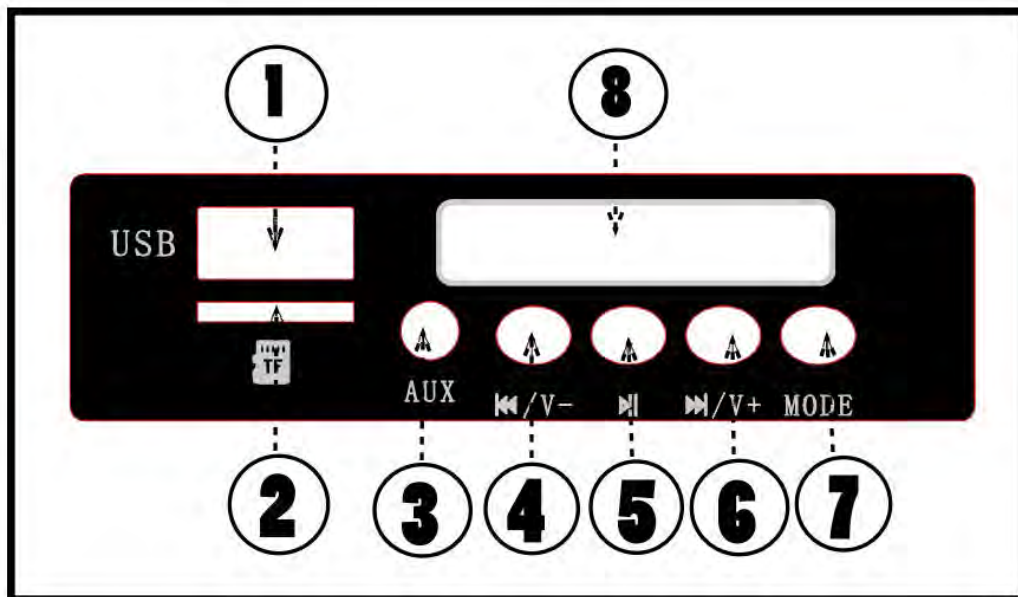

- ① USB socket: insert USB terminal, connect audio source, can play audio;
- ② TF card socket: insert TF card, can play audio;
- ③ MP3 socket: through the data line can be connected to other devices and play audio;
- ④ Music switching / volume reduction: touch the button, switch the music, press the button long, the volume is down;
- ⑤ Pause button: touch this button, pause the audio playing;
- ⑥ Volume / music keystroke: long press this key, volume increase, touch this key, play music;
- ⑦ Mode switching button: touch the button to play MP3 music, then touch the button to play the music in the USB, and then touch the button to play the music in the USB card.
- ⑧ battery is charged or not. (single drive: charge below 6.2V; double drive: charge below 12.5V)

## (6) How to use the steering wheel button



# How To Operate Your Vehicle

## Circuit diagram

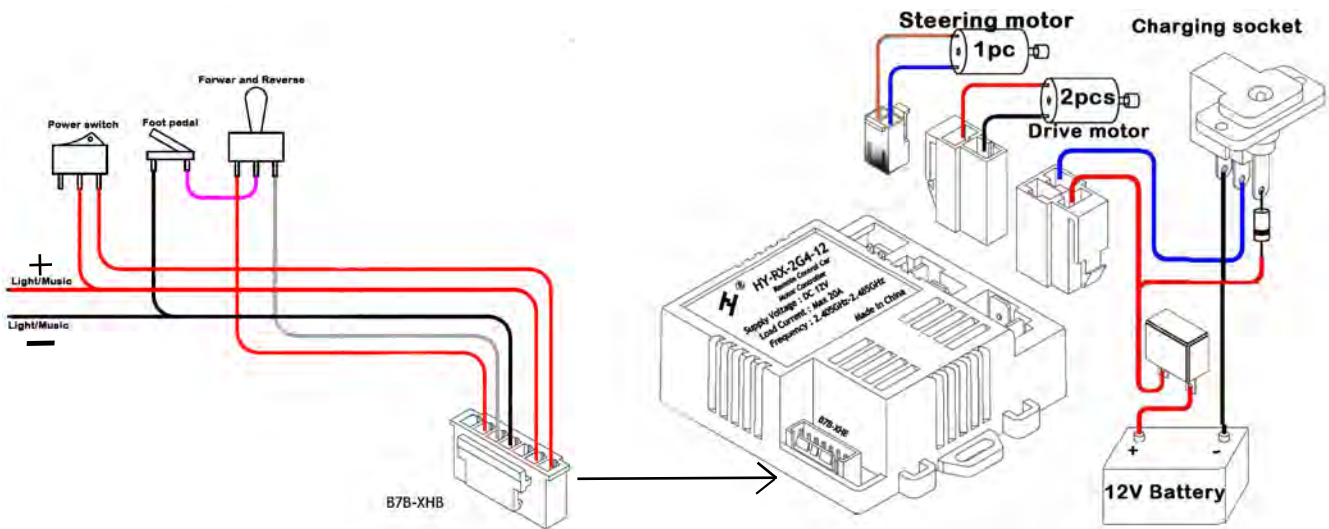

## Charging Your Vehicle

ONLY AN ADULT CAN CHARGE AND RECHARGE THE BATTERY!

### **WARNING!**

#### • **PREVENT FIRE AND ELECTRIC SHOCK:**

- Use the only rechargeable battery and charger supplied with your vehicle. NEVER substitute the battery or the charger with another brand. Using another battery or charger may cause a fire or explosion.
  - Do not use the battery or charger for any other product. Overheating, fire or explosion could occur.
  - NEVER modify the electric circuit system. Tampering with the electric system may cause a shock, fire or explosion or may permanently damage the system.
  - Do not allow direct contact between battery terminals. Fire or explosion can occur.
  - Do not allow any type of liquid on the battery or its components.
  - Explosive gasses are created during charging. Do not charge near heat or flammable materials. Charge the battery in a well-ventilated area ONLY.
  - NEVER pick up the battery by the wires or charger. Damage can occur to the battery and may cause a fire. Pick up the battery by the case ONLY.
  - Charge the battery in a dry area ONLY.
- Remove high-lighted section. **Wash hands after handling.**
  - Do not open the battery. Battery contains lead acid and other materials that are toxic and corrosive.

# Charging Your Vehicle

## **WARNING!**

### • **PREVENT FIRE AND ELECTRIC SHOCK:**

- Do not open the charger. Exposed wiring and circuitry inside case may cause electric shock. Only adults may handle or charge the battery. NEVER allow child to handle or charge the battery. Battery is heavy and contains lead acid (electrolyte).
- Do not drop the battery. Permanent damage to the battery could occur or cause serious injury.
- Before charging the battery, check for wear or damage to the battery, charger, its supply cord and the connectors. DO NOT charge the battery if any damage to parts has occurred.
- Do not allow the battery to drain completely. Recharge the battery after each use or once a month if not used regularly.
- Do not charge battery upside down.
- Always secure the battery with the bracket. Battery can fall out and injure a child if vehicle tips over.
- A recommendation for adult supervision of young children.
- The toy should be used with caution since skill is required to avoid falls or collisions causing injury to the user or third parties.

- The charging input socket is **BELOW THE SEAT**.
- The **POWER SWITCH** must be turned in **OFF** position when charging.
- Before the first use, you should charge the battery for 8-12 hours. Do not recharge the battery for more than 20 hours to avoid overheating the charger.
- When the vehicle begins to run slowly, recharge the battery.
- After each use or once a month minimum recharge time as 8 to 12 hours, no more than 20 hours.

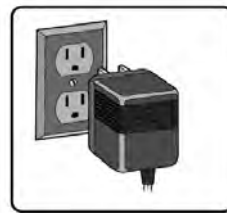

## **WARNING!**

**This product with CHARGING PROTECTION:  
When charging, all the functions will be cut off!**

1. Find The charging input socket below the seat;
2. Plug the charger port into the input socket;
3. Plug the charger plug into a wall outlet. The battery will begin

# Troubleshooting Guide

---

## ■ PROBLEM: The vehicle does not run

**PROBLEM CAUSE: The battery may low on power.**

After each use, or once a month minimum, charge the battery for 8-12 hours. Do not leave the battery on the charger for more than 20 hours.

**POSSIBLE CAUSE: Thermal fuse has tripped.**

The vehicle is equipped with a self-resetting fuse. When the vehicle is overloaded or operated incorrectly; the self-resetting fuse will be cut off for 5-20 seconds before becoming operational again. The self-resetting fuse is under the seat (Refer to the picture.)

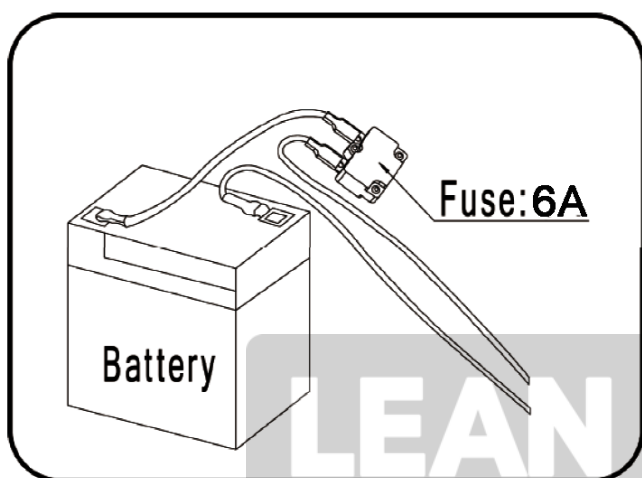

**To avoid the fuse cut off the power, follow these guidelines:**

DO NOT overload the vehicle, Maximum weight allowed : 25 kg

DO NOT tow anything behind the vehicle.

DO NOT drive up steep slopes.

DO NOT drive into fixed objects, which may cause the wheels to spin, causing the motor to overheat.

DO NOT drive in very hot weather, components may overheat.

DO NOT tamper with the electric system, Doing so may create a short circuit, causing the fuse to trip.

**POSSIBLE CAUSE: Wheel nuts are loose.**

If the nuts are not tight, the wheels will not engage the forward gears. Tighten the nut with the nut wrench.

**POSSIBLE CAUSE: Battery connector or wires are loose.**

Make Sure the battery connectors are firmly plugged in to each other.

**POSSIBLE CAUSE: Battery is dead.**

Have you properly maintained the battery according to the directions? Is the battery old? Your battery may need to be replaced.

**POSSIBLE CAUSE: Electric system is damaged.**

Water may have corroded the system, or loose dirt, gravel or sand might have jammed the switch.

**POSSIBLE CAUSE: Motor is damaged.**

The motor needs professional repair.

## ■ PROBLEM: The battery will not recharge.

**POSSIBLE CAUSE: Battery connector or adapter connector is loose.**

Make sure the battery connector and adapter connector are firmly plugged together.

**POSSIBLE CAUSE: Charger is not plugged in.**

Make sure the charger is plugged into the wall outlet and the power flow to the outlet is on.

**POSSIBLE CAUSE: Charger is not working.**

Is the charger warm while charging? If not, the charger may be broken and may need to be replaced.

# Troubleshooting Guide

---

## ■ **PROBLEM: The vehicle does not run very long.**

### **POSSIBLE CAUSE: Battery may be undercharged.**

You may not be charging the battery long enough. After each use, or once a month minimum, charge the battery for 8 to 12 hours. Do not leave the battery on the charger for more than 20 hours.

### **POSSIBLE CAUSE: Battery is old.**

The battery will eventually lose the ability to hold a charge. Depending on the amount of use, and varying conditions, the battery should operate for one to three years. Replace the battery with a new One.

## ■ **PROBLEM: Battery buzzes or gurgles when charging.**

This is normal and not a cause for concern. It may also be silent when charging, which is also normal.

## ■ **PROBLEM: Charger feels warm when recharging battery.**

This is normal and not a cause for concern.

# Maintaining Your Vehicle

---

- It is parents' responsibility to check main parts of the toy before using, Must regularly examine for potential hazard, such as the battery, charge, cable or cord, plug, screws are fastening enclosure of other parts and that in the event of such damage, the toy must not be until that damage had been properly removed.
- Make sure the plastic parts of the vehicle are not cracked or broken.
- Occasionally use a lightweight oil to lubricate moving parts such as wheels.
- Park the vehicle indoors or cover it with a tarp to protect it from wet weather.
- Keep the vehicle away from sources of heat, such as stoves and heaters. Plastic parts may melt.
- Recharge the battery after each use. Only an adult can handle the battery. Recharge the battery at least once a month when the vehicle Raider is not being used.
- Do not wash the vehicle with a hose. Do not wash the vehicle with soap and water. Do not drive the vehicle in rainy or snowy weather. Water will damage the motor, electric system and battery.
- Clean the vehicle with a soft, dry cloth. To restore shine to plastic parts, use a non-wax furniture polish. Do not use car wax. Do not use abrasive cleaners.
- Do not drive the vehicle in loose dirt, sand or fine gravel which could damage moving parts, motors or the electric system.
- When not using, all the electrical source should be turn off. Turn off the power switch and disconnect the battery connection.

# Disposal Of Battery

---

## Disposal Of Battery



- Your sealed lead-acid battery must be recycled or disposed of in an environmentally sound manner.
- Do not dispose of your lead-acid battery in a fire. The battery may explode or leak.
- Do not dispose of a lead-acid battery in your regular, household trash. The incineration, land filling or mixing of sealed lead-acid batteries with household trash is prohibited by law.
- Return an exhausted battery to your local approved lead-acid battery recycle, such as a local seller of automotive batteries.
- Contact your local waste management officials for other information regarding the environmentally sound recycling and disposal of lead-acid batteries.
- The battery must be charged only by adult .Please charge the product before using!
- The toy should not be connected to excessive powers (more than the quantity specified herein), and it should not be operated during charging process.
- Any rechargeable battery must only be charged under adult's supervision.
- Battery charger shall regularly check the wires, plugs, casing and other parts for damage and found damage should stop using and restored.
- Open the battery cover on the remote control, and put two pieces of batteries, paying attention to batteries polarity. Replace the battery cover and lock with screws (please replace the battery according to the above steps and should be done by adult) .
- All batteries should be inserted with the correct polarity.
- Non-rechargeable battery should not be charged, please remove any running-off battery from the toy.
- Do not use old and new batteries together, or mix different types of batteries.
- The battery charger used with the toy are to be regularly examined for damage to the cord, plug, enclosure and other parts, and in the event of such damage, they must not be used until that damage had been repaired.